

Quick Guide Gas Flowmeter GD 300 / GD 500 and GD 300 Ex / GD 500 Ex

Information

Thank you for your understanding, that we do not enclose a complete instruction manual or datasheet. You have the opportunity to download all relevant information and from our website (www.esters.de).

Download complete instruction manual → www.esters.de/en/download/mi000.shtml#FLOW

Download datasheet → www.esters.de/en/download/ds000.shtml#FLOW



Scope of supply

- Gas Flowmeter GD 300 / GD 500 and GD 300 Ex / GD 500 Ex (ATEX version)
- Integrated calculator HB 300 or HB 300 Ex (ATEX version)
- Integrated platinum wire sensor
- Quick Guide for installation QG 312/313 E
- Factory calibration certificate

Target groups and qualifications

Only properly trained personnel authorised by the owner of the system shall be permitted to install, start up, and maintain the product. The respective technical personnel must have read and understood the instructions and must follow the directions. Before using corrosive or abrasive test fluids, it is the owner's responsibility to verify the resistance of those parts that contact the measuring medium. The owner must comply with the national rules and regulations governed by the country with respect to installation, function testing, repair, and maintenance of electrical products.

Safety instructions:

- Only properly trained personnel shall be permitted to work on/with systems containing gases and shall be authorized to install, execute settings, and perform the initial operation of the equipment. In doing so, compliance with all commonly accepted engineering standards and adherence to regulations to the occupational health and safety act is mandatory.
- Prior to installing and/or removing components of gas-carrying systems, ensure the system is shut down and depressurized.
- Before the initial start-up and/or restart of the system, ensure that all personnel and objects are out of reach of moving parts. Noncompliance with these instructions or technical advice may lead to personal injuries and/or damage to property.

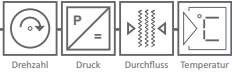

Mounting the Gas Flowmeter GD 300 / GD 500 and GD 300 Ex / GD 500 Ex

Mounting instruction

Before installing the measuring unit, ensure that the nominal size stated on the type plate matches the actual nominal diameter of the pipe!

Ex registration data
(only GD 300 Ex/GD 500 Ex):

CE 0123  II 1/2 G Ex ia / e mb IIC T4 Ga / Gb
TPS 13 ATEX 14689 003

Manufacturer	: Esters Elektronik GmbH, Germany
Year of manufacture	: 10/2018
Type	: GD 300Ex-25030SIR1000-V4-P0R0
Serial	: 1810 A12345
Resolution	: 13,3125 l/pulse
Max. gas Temp. / amb. Temp.	: 80 °C / 45 °C
Max. pressure	: 0,5 bar
Range	: 75 - 7500 Bm ³ /h
Protection class	: IP65
Diameter nominal	: 250
Weight	: 32,5kg

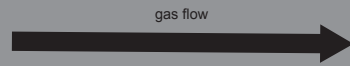

Mounting position

The flowmeter can be installed in a horizontal or vertical position in the pipe system for dry gases. For humid gases installation in a horizontal position or in a falling direction is mandatory. In order to achieve the specified measuring accuracy, the following installation conditions must be observed:

- Defined lengths of inlet and outflow zone
For the GD 300 / GD 300 Ex, the inlet and outlet sections must be observed when installing in the piping system. This does not apply to the GD 500 / GD 500 Ex, the device can be installed directly in the piping system.
- Defined flow cross-sectional area
- Defined orifices
- Correct positional arrangement of the measuring elements

When installing the flowmeter, please ensure the directional arrow on the identification plate points in the direction of the flow.

Inlet and outlet pipe lengths for GD 300 / GD 300 Ex

Standard installation with straight pipe

Inlet pipe length: 10 x DN (nominal width)
Outlet pipe length: 5 x DN (nominal width)

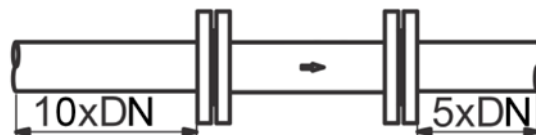

Installation with bended pipe I

Inlet pipe length: 25 x DN (nominal width)
Outlet pipe length: 5 x DN (nominal width)

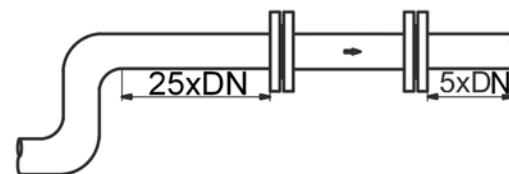

Installation with bended pipe II

Inlet pipe length: 20 x DN (nominal width)
Outlet pipe length: 5 x DN (nominal width)

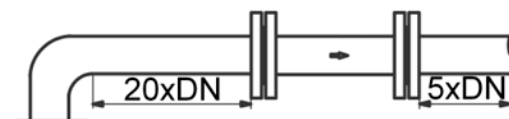

Installation with flaring pipe

Inlet pipe length: 20 x DN (nominal width)
Outlet pipe length: 5 x DN (nominal width)



Rev.-Nr.: GD 300_500-QG 312_313 E-V0.2 2019-12-04

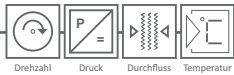

Installation with tapered pipe

Inlet pipe length: 15 x DN (nominal width)
Outlet pipe length: 5 x DN (nominal width)



Installation with elbow pipe

Inlet pipe length: 40 x DN (nominal width)
Outlet pipe length: 5 x DN (nominal width)

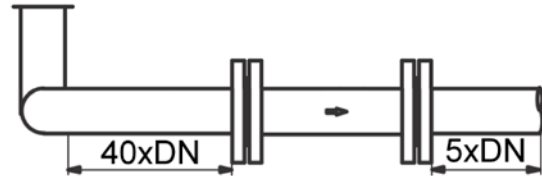

Installation with shut-off valve

Inlet pipe length: 50 x DN (nominal width)
Outlet pipe length: 5 x DN (nominal width)



Further installation instructions regarding the different pipe versions (GD 300 / GD300 Ex: flange design, internal pipe thread and GD 500 / GD 500 Ex: external pipe thread) can be found in the instruction manual IM 312/313 E.

Connection of integrated calculator HB 300 / HB 300 Ex

Installation/ Safety Notice

Before installation, make sure that the power supply complies with the technical specifications.

- Connect only in switched-off state
- Install overvoltage protection in case of overvoltage or voltage peaks
- Any gas leakage is to be avoided

Manufacturer	: Esters Elektronik GmbH, Germany
Type	: HB 300 Ex-R012146
Serial	: 1810 A100123
Serial GD 300 Ex	: 1810 A12345
Fixed value temp.	: 28 °C
Fixed value pres.	: 5 bar
Current loop type	: 4 - 20 mA
Current loop range	: 0 - 7000 Nm ³ /h
Weighted pulse	: 10 Nm ³ /pulse
Standardisation	: DIN 1343

Configuration	Description
p	Pulse 24V DC output
S	Status sensor
+I _{out}	04-20 mA / 0-20 mA output
┴	Ground
+24 V DC	24 V DC power supply
Shield	Shield



Intrinsically safe circuit (only HB 300 Ex)

From the requirements of the ATEX directives, there need to be made special arrangements made in view of the circuit design and assembly of the HB 300 Ex.

The GD 300 Ex / GD 500 Ex is an intrinsically safe device, guaranteed by the HB 300 Ex. Safe operation is ensured only by adhering to the operating instructions and the EC type examination certificate. The potted area of the HB 300 Ex must not be opened and no changes must be made!

In potentially explosive atmospheres, the relevant regulations, conformity and type examination certificates of the sensors and the power supply units must be observed.

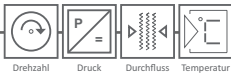

Technical data

OPERATING VOLTAGE	24 V, DC
POWER INPUT	max. 110 mA
ATEX CERTIFICATION (ONLY HB 300 Ex)	CE 0123 Ex II 1 / 2 G Ex ia / e mb IIC T4 Ga / Gb, EG-certification no.: TPS 13 ATEX 14689 003 X (certificate no. EX5 13 07 14689 003)
CABLE LENGTH	max. 300 m
NATIVE PULSE OUTPUT HB 300 -R000000/ HB 300 Ex-R000000	pulse 24 V, DC, max. 200 Hz (pulse width 1 - 2 ms) status output for sensor break detection: 24 V, DC (pollution monitoring with redundant platinum wire sensor), external flow computer required (e.g. GDR 1403, GDR 1404, ...)
OUTPUT WITH INTEGRATED CALCULATOR HB 300 -R0XXXXX/ HB 300 Ex-R0XXXXX	pulse output: pulse 24 V, DC, 1 pulse=0.01, 0. 1, 1, 10 or 100 m ³ current interface: (0)4 - 20 mA = 0 - x Nm ³ /h , status utput for sensor break detection: 24 V, DC (pollution monitoring with redundant platinum wire sensor) standard: DIN 1343, DIN 6358, DIN ISO 2533, DIN 102/ISO 1-1975 fixed value temperature: -50 °C to +400°C fixed value absolute pressure: -0 bar to 30 bar fixed value hydr. pressure: -0,8 bar bis 1,2 bar

Overview connection

The GD 300 / GD 300 Ex and GD 500 / GD 500 Ex have a 6-pole process connection on the HB 300 / HB 300 Ex. The labyrinth cover has a cable gland and a blanking plug. The connection cable passes through the cable gland to the process connection of the HB 300 / HB 300 Ex.

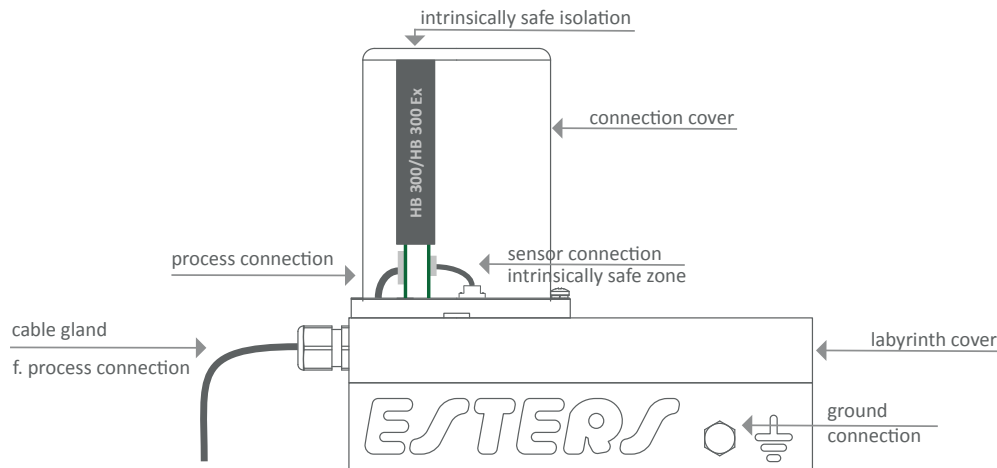

- In the intrinsically safe connection area, the connection of the platinum wire sensor (sensor connection) is provided with a 2-pin connection terminal. The terminals are reverse polarity protected. When the gas flowmeter is delivered, the sensor is already connected, but otherwise the sensor must only be connected in de-energized state (see service - sensor replacement, page 7).
- Depending on the signal interface, you can connect the cables to the process connection in accordance with the following connection diagram. For this purpose, a suitable cable acc. to the following cable recommendations is required. Only if the cable cross-section is maintained a correct sealing is ensured.
- The GD 300 / GD 300 Ex and GD 500 / GD 500 Ex must be integrated into the lightning protection concept of the plant operator. The ground connection is located at the measuring head, where the grounding line can be connected. The design of the flowmeter ensures complete grounding when properly connected.

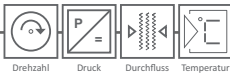

Cable recommendation for process connection

In potentially explosive areas with ignition protection type "I" – intrinsic safety, the cables must meet the requirements of VDE 0165-1 (DIN EN 60079-14). The sensor is equipped with a special cable LAPPKABEL ÖLFLEX EB CY.

Depending on the application for connecting the signal outputs to a flow computer or the PLC, we recommend the following cables:

APPLICATION	CABLE TYPE	CABLE CROSS SECTION	OUTER DIAMETER
INSIDE (NO UV EXPOSURE)	UNITRONIC LiYCY order no. 0034506 or equivalent	6 x 0,34 mm ² with shielding made of tinned copper braid	4-8 mm
OUTDOORS (increased UV exposure)	UNITRONIC LiYCY order no. 0034506 or equivalent	6 x 0,34 mm ² with shielding made of tinned copper braid	4-8 mm

Due to increased UV exposure UV resistant cable ducts must be used.

Alternatives depending on application:

APPLICATION	CABLE TYPE	CABLE CROSS SECTION	OUTER DIAMETER
INSIDE (NO UV EXPOSURE)	UNITRONIC LiYCY order no. 0034604 or equivalent	4 x 0,5 mm ² with shielding made of tinned copper braid	4-8 mm
OUTDOORS (increased UV exposure)	UNITRONIC LiYCY order no. 0034604 or equivalent	4 x 0,5 mm ² with shielding made of tinned copper braid	4-8 mm

Due to increased UV exposure UV resistant cable ducts must be used.

Connection diagram HB 300 / HB 300 Ex (process connection)

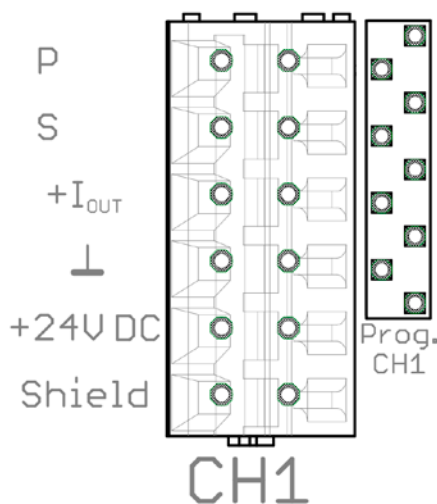

TERMINAL ASSIGNMENT	DESCRIPTION
CHANNEL 1 (CH1)	
P	pulse out, depending on version: - native pulse output with defined litre/pulse or - pulse output with integrated calculator, alternatively with actual or standard cubic meters with variable pulse weigh: 1Puls = 0,01L;0,1L;1L;10L;100L
S	status info
+I _{OUT}	(0) 4 - 20 mA output
⊥	ground
+ 24 V, DC	24 V DC power supply
SHIELD	shield

Rev.-Nr.: GD 300_500-QG 312_313 E-V0.2 2019-12-04

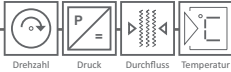

- Opening the connection cover
The process connection for HB 300 / HB 300 Ex is located inside
Please note, the connection cover may not be damaged in the area of the o-ring and the surrounding metal surfaces. The same applies to the o-ring itself. Damages lead to loss of tightness.
- At the end of the cable in the direction of the process connection the insulation must be removed on max. 60 mm length. The individual wires are to be provided with suitable ferrules. The shield must be soldered to a wire and be equipped with a suitable ferrule sleeve.
- Loop the cable around the process connection and contact the individual wires according to the connection diagram.
- After inserting the cable, the cable glands must be secured.
- It is essential to ensure that supplied cable may be routed freely without securing it for a maximum of 300 mm after the cable gland. If a larger distance is to be laid free, a separate cable gland with strain relief must be used.
- The maximum cable length of the process connection should not exceed 300 m.

Commissioning

Inspection prior to commissioning

Before commissioning, the following items must be checked:

- The supply voltage and/or the flow computer must be switched off.
- The pin assignment must be carried out according to the connection diagram.
- The device must be connected to the ground.
- The temperature limits must be adhered to.

Carrying out the commissioning

- Turning on auxiliary power:
After switching on the supply voltage and/or the flow computer, readiness for operation can be read on the connected flow computer or on the PLC. If the device is correctly connected, the measured values are output to the higher-level systems.
- Setting device:
On the flowmeter GD 300 / GD 300 Ex and GD 500 / GD 500 Ex no settings have to be made.
All data required for operation, such as the liter/pulse rate can be found on the type plate or the calibration record.

Note on voltage/current consumption

The switch-on behavior corresponds to the draft DIN IEC 65C / 155 / CDV of June 1996. The average current consumption of the device is 10 mA. In the event of a fault, the integrated FDE function (Fault Disconnection Electronic) ensures a limitation of max. 13 mA of the current consumption. The upper limit of the electricity is electronically limited. The supply voltage is 7.5, V DC. In combination with the HB 300 / HB 300 Ex it is an intrinsically safe version.

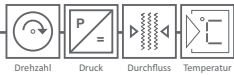

Service - sensor replacement

Here is a short list of the steps which are necessary to replace the platinum wire sensor. Additional details can be found in the instruction manual IM 312 / 313 E.

- Opening the connection cover
Inside the sensor connection is located
Please note, that the connection cover may not be damaged in the area of the o-ring and the surrounding metal surfaces. The same applies to the o-ring itself. Damages lead to loss of tightness.
- Removal and installation of the platinum wire sensor
The platinum wire of the sensor can be easily damaged. It is a 15 µm thick platinum wire used to detect the flow. During disassembly and assembly, make sure that the wire is not damaged. The sensor must be pulled out straight (perpendicular to the sensor center point) of the sensor attachment. The sensor pins must not touch the metal of the labyrinth lid during removal and installation.
- Checking the functionality of the platinum wire sensor
Check the sensor for function after each installation. Measure the resistance of the platinum wire sensor with the aid of an ohmmeter. Between the sensor connections 36 - 44 ohms should be measurable. If a different value is measured, the unit is damaged and can no longer be used.

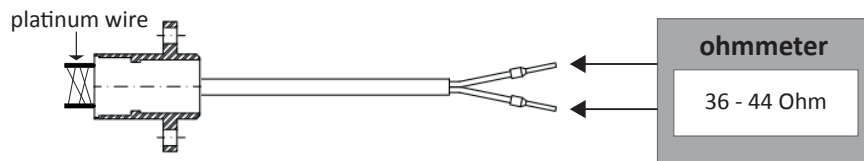

- Mounting the connection cover
Mount the connection cover again. Please note that special o-rings are used to seal the GD 300 / GD 300 Ex and GD 500 / GD 500 Ex flowmeter. To ensure perfect fitting, the o-ring must be treated with a suitable lubricant. For use we recommend Würth silicone spray (art. no.0893223).
Please note that due to aging processes, temperature and environmental influences, the lubricating effect of the lubricant may decrease. After opening the connection cover, check whether re-wetting of the o-ring is required. For this you can use the finger test. Swipe your fingertip over the o-ring without much pressure. If friction is felt, treat the o-ring with the recommended lubricant.

Rev-Nr.: GD 300_500-QG 312_313 E-V0.2 2019-12-04

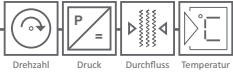

Notes

Rev-Nr.: GD 300_500-QG 312_313 E-V0.2 2019-12-04